

## Shower set without hand shower - Chrome

IMO

26 413 979



Fits: IMO, LULU, MEM, TARA, CL.1, LISSÉ,  
VAIA, META, CYO

- slide bar
- Pipe diameter 18 mm
- gauge 853 mm
- metal shower hose 1750mm with integrated anti-twist protection
- shower hose connector 3/8"

This article does not include a hand shower!

|   |                                     |               |
|---|-------------------------------------|---------------|
|    | Chrome                              | 26 413 979-00 |
|    | Brushed Platinum                    | 26 413 979-06 |
|    | Platinum                            | 26 413 979-08 |
|    | Dark Chrome                         | 26 413 979-19 |
|    | Light Gold                          | 26 413 979-26 |
|    | Brushed Light Gold                  | 26 413 979-27 |
|    | Brushed Durabronze<br>(23kt Gold)   | 26 413 979-28 |
|    | Matte Black                         | 26 413 979-33 |
|    | Brushed Bronze                      | 26 413 979-42 |
|   | Brushed<br>Champagne (22kt<br>Gold) | 26 413 979-46 |
|  | Champagne (22kt<br>Gold)            | 26 413 979-47 |
|  | Brushed Chrome                      | 26 413 979-93 |
|  | Brushed Dark<br>Platinum            | 26 413 979-99 |

26 413 979

Recommended miscellaneous

|   |  |               |
|---|--|---------------|
|  | <b>Concealed wall elbow -</b><br>●max. recess depth 163 mm<br>●min. recess depth 90 mm | 35 085 970 90 |
|---|--|---------------|

Recommended miscellaneous

|   |                                  |               |
|---|----------------------------------|---------------|
|  | <b>LISSÉ Wall elbow - Chrome</b> | 28 450 845-00 |
|---|----------------------------------|---------------|

Required miscellaneous

|   |  |                       |
|---|--|-----------------------|
|  | <b>Hand shower FlowReduce - Chrome</b><br>●Max. flow rate 6.8 l/min (at 3 bar) | 28 016 979-00<br>0010 |
|---|--|-----------------------|

Required miscellaneous

|   |  |               |
|---|--|---------------|
|  | <b>Hand shower - Chrome</b><br>●Max. flow rate 15 l/min (at 3 bar) | 28 017 979-00 |
|---|--|---------------|

Required miscellaneous

|   |  |               |
|---|--|---------------|
|  | <b>Hand shower - Chrome</b><br>●Max. flow rate 15 l/min (at 3 bar) | 28 012 979-00 |
|---|--|---------------|

Required miscellaneous

|   |  |                       |
|---|--|-----------------------|
|  | <b>Hand shower FlowReduce - Chrome</b><br>●Max. flow rate 6.8 l/min (at 3 bar) | 28 018 979-00<br>0010 |
|---|--|-----------------------|

Recommended miscellaneous

|   |                            |               |
|---|----------------------------|---------------|
|  | <b>Wall elbow - Chrome</b> | 28 450 980-00 |
|---|----------------------------|---------------|

Required miscellaneous

|   |  |               |
|---|--|---------------|
|  | <b>Hand shower - Chrome</b><br>●Max. flow rate 15 l/min (at 3 bar) | 28 015 979-00 |
|---|--|---------------|

Required miscellaneous

|   |  |                       |
|---|--|-----------------------|
|  | <b>Hand shower FlowReduce - Chrome</b><br>●Max. flow rate 6.8 l/min (at 3 bar) | 28 012 979-00<br>0010 |
|---|--|-----------------------|

Required miscellaneous

|   |  |               |
|---|--|---------------|
|  | <b>Hand shower - Chrome</b><br>●Max. flow rate 15 l/min (at 3 bar) | 28 016 979-00 |
|---|--|---------------|

Required miscellaneous

|   |  |               |
|---|--|---------------|
|  | <b>Hand shower - Chrome</b><br>●Max. flow rate 15 l/min (at 3 bar) | 28 018 979-00 |
|---|--|---------------|

26 413 979

mm [inches]

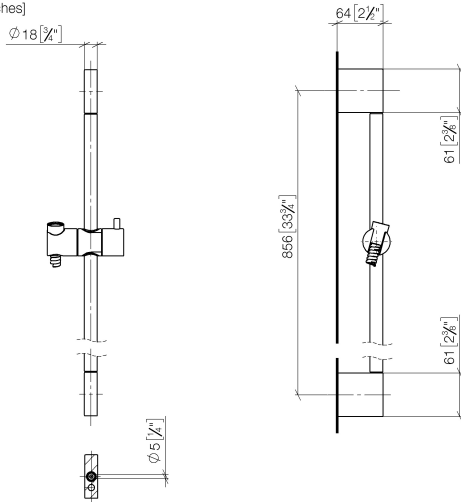

Certificates

WRAS\_2009048. ACS\_20 ACC LY 738. IAPMO\_4976 (1).

26 413 979

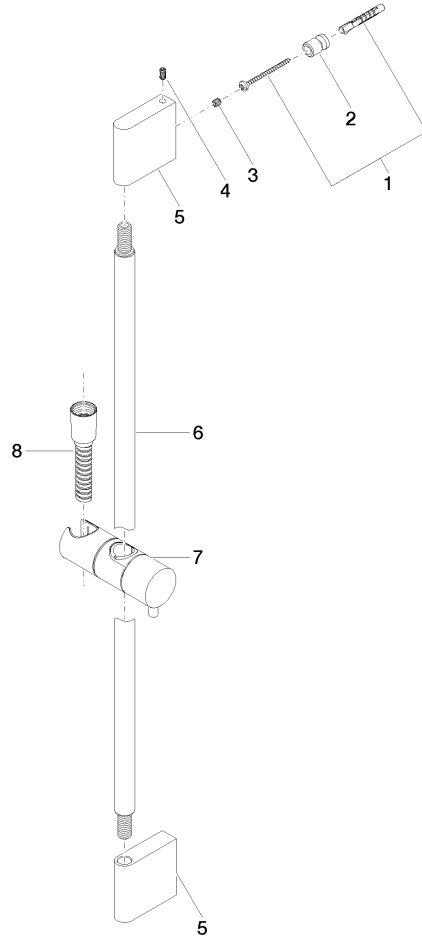

Spare parts list

| No. | Item Number        | Name   | Quantity used | Delivery time |
|-----|--------------------|--|---------------|---------------|
| 1   | 05 17 20 726 02 90 | fixing set                                       | 2             | 2             |
| 2   | 08 17 20 726 90    | holder   | 2             | 2             |
| 3   | 09 31 11 049 90    | pin  | 2             | 2             |
| 4   | 04 31 11 113 00 90 | pin  | 2             | 2             |
| 5   | 08 17 97 054-00    | holder   | 2             | 10            |
| 6   | 90 28 22 597 00-00 | holder   | 1             | 10            |
| 7   | 12 580 970-00      | Slide unit - Chrome                              | 1             | 10            |
| 8   | 28 322 970-00      | Metal shower hose 1/2" x 3/8" x 1750 mm - Chrome | 1             | 2             |